

## FS80-C Flow Switch

### Description

- 1) FS80-C Flow Switch responds to fluid flow in lines carrying water, ethylene glycol, or other Non-hazardous fluids
- 2) FS80-C Flow Switch uses a variety of paddle sizes to respond to fluid flow rates in applications with pipe sizes greater than 1-inch trade size
- 3) Single-Pole, Double-Throw (SPDT) flow switch that can be wired to energize one device and de-energize another device powered from the same source when liquid flow either exceeds or drop below the set flow rates



Figure 1 FS80-C Flow Switch

Features and Benefits	
Maximum fluid pressure of 1.5MPa	Permits use in a wide range of pressure flow conditions.
Adjustment Flow Switch Paddle	Allows from 1 in. to 6 in. pipe application
Adjustable Flow Rate Range	Allows user select the setting according the needs of system
IP55 Enclosure	Allows use in indoor or outdoor applications

### Application

#### FS80-C Flow Switch

**IMPORTANT: FS80-C Flow Switch is designed for use only as operating controls. Where an operating control failure would result in personal injury and/or loss of property, it is the responsibility of the installer to add devices (safety, limit controls) that protect against, or systems (alarm, Supervisory systems) that warn of, control failure.**

Use FS80-C Flow Switch in application with fluid pressures up to 1.5MPa. A typical application for FS80-C flow switch is to shut down the refrigeration compressor on a fluid chiller system if flow stops, reducing chances of chiller freeze-ups.

#### IP55 Enclosures

Use IP55 enclosures of FS80-C flow switch for indoor or outdoor applications in high-humidity environments. Use this model with pipes carrying fluids at temperatures in the range of -25~110°C where fluid temperatures are above ambient dew point.

The SPDT switch on the FS80-C has color-coded terminals. Red is common, and closed to Blue upon flow increase and to Yellow upon flow decrease. See Figure 2 and Table 1 for switch action and flow rates.

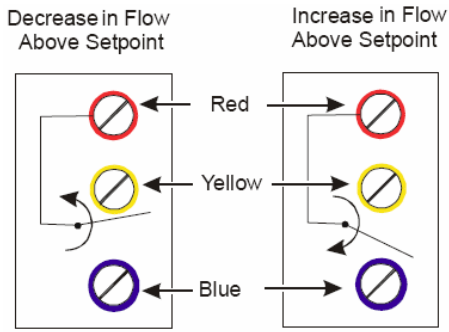

Figure 2 Switch Action

## INSTALLATION AND WIRING

### Adjusting the Flow Switch Paddle

**IMPORTANT:** To allow the switch to detect changes in the flow condition, the paddle must not touch the pipe or any restrictions in the pipe.

**IMPORTANT:** Do not use FS80-C on systems with flow velocity greater than 3m/sec.

- FS80-C Flow Switch comes with 4-piece paddle (1 in., 2 in., 3 in., and 6 in. segments). Adjust the paddle to the size of the pipe in which it will be installed. If needed, use the template (see Figure 5), and trim the large paddle at the arc corresponding to pipe size and install.

**Example, if 3" pipe is used, Install 1" ,2" and 3" segments (see figure 3), if 1-1/2 pipe is used, trim the 2" paddle to the pipe size or use the 1" paddle segment.**

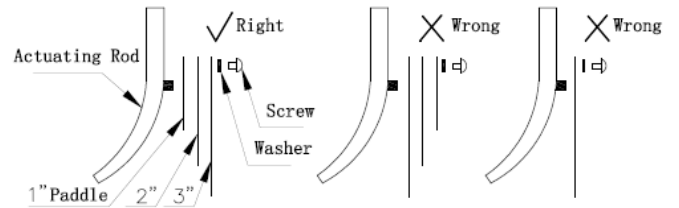

Figure 3 Paddle Installation Example

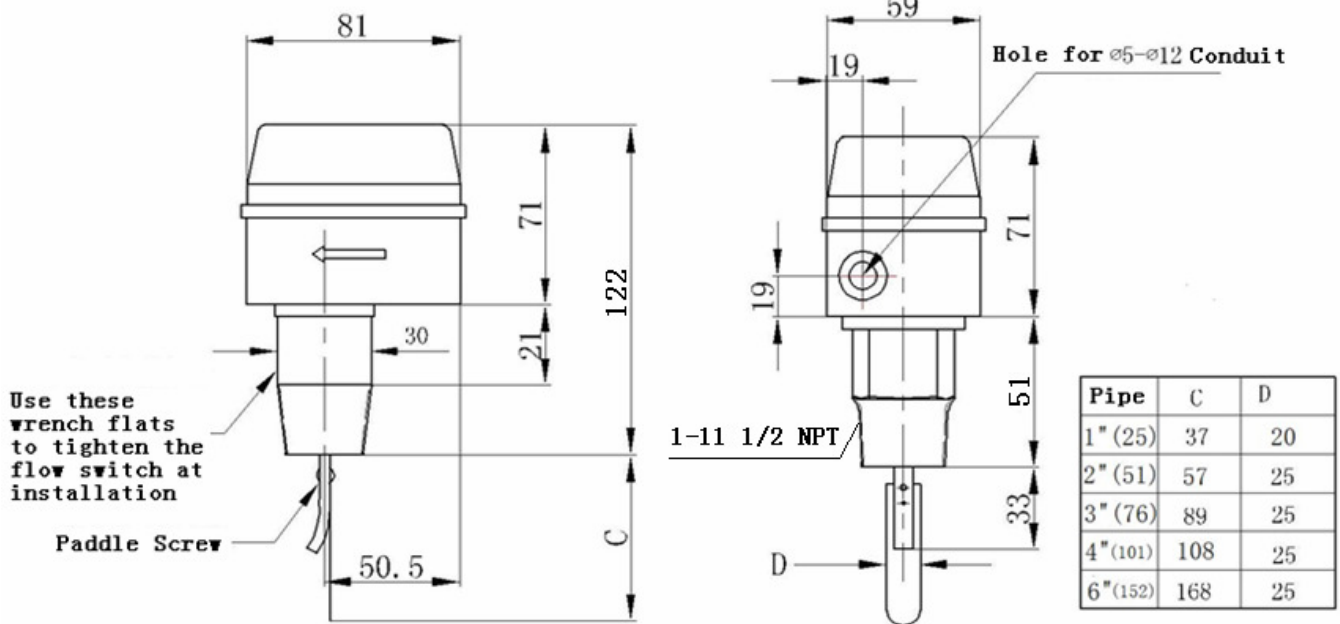

Figure 4 Dimensions (mm)

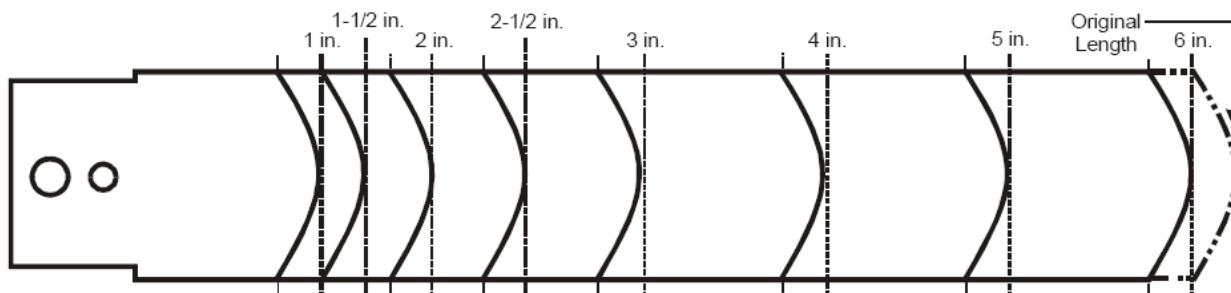

Figure 5 Teimming Template for the Extra Paddle

- Mount the FS80-C in a section of pipe where there is a straight run of at least five pipe diameters on each side of the Flow Switch. See Figure 6

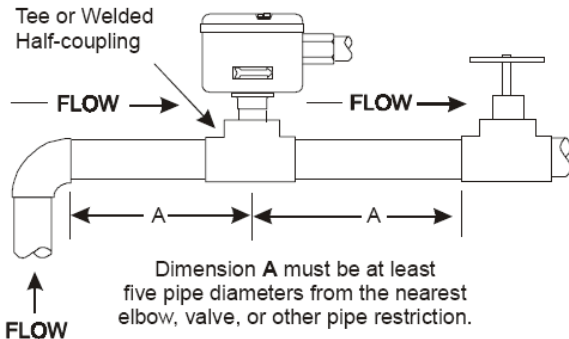

Figure 6 Typical Installation

- The switch should be mounted so the terminals or wire leads are easily accessible for wiring

Note: These flow switch must not be subjected to water hammer. If a fast-closing valve is located downstream of the flow switch, a suitable water hammer arrester must be used. See figure 7.

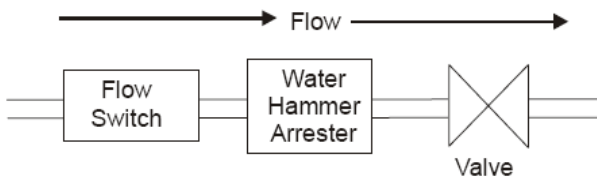

Figure 7 Arrester Location Schematic

- Mount the flow switch in a standard 1 in.x 1 in.x 1 in. tee for 1 in. pipe installation. Use a reducing tee for larger sizes of pipe to keep the flow switch close to the pipe and provide adequate paddle length in the flow stream

Example: Use a 2 in.x 2 in.x 2 in. tee for a 2 in. pipe. If a standard 2 in.x 2 in.x 2 in. tee is used, install a face or hex bushing in the top opening to reduce it to 1 inch.

**CAUTION: Equipment damage hazard.**

**To avoid damaging the switch, do not tighten the switch to the tee by grasping the switch enclosure. Use only the wrench flats provided (see Figure 4).**

- Screw the flow switch in position so the flat of the paddle is at a right angle to the flow. The arrow on the side of the case must point in the direction of the flow

- FS80-C flow switch may be mounted in a horizontal pipe line or a vertical pipe line with upward liquid flow. It is not recommended for installations where flow is downward. When mounted in a vertical pipe with upward flow, the switch will trip at a slightly higher flow than shown in table 1 *Typical Flow Rates*, due to the effect of gravity on the switch mechanism

**Wiring**

**WARNING: Shock hazard**

**Disconnect the power supply before the wiring connections are made to avoid possible electrical shock or damage to the equipment.**

- Make all wiring connections using copper conductors only
- Use the terminal screw furnished. Substitution of other screws will void the warranty and agency approvals.

**Adjustments**

**CAUTION: Improper operation hazard**

**The switch is factory set at approximately the minimum flow rate (see table 1 *Typical Flow Rate*). Do not set lower than the factory setting as this may result in the switch failing to return to a “no flow” position.**

**CAUTION: Equipment damage hazard**

**Sealed settings (screws marked with red paint) are not intended to be changed. Adjustment attempts may damage the control or cause loss of calibration, voiding the warranty.**

**To adjust the setting of the flow switch:**

1. Remove the FS80-C cover.
2. For higher flow rates, turn the adjusting screw clockwise. To lower the flow rates after it has been raised from the factory setting, turn the adjusting screw counterclockwise. See Figure 2.
3. Check to see that the flow switch is not set lower than factory setting by depressing the main lever numerous

times. If the lever fails to “click” upon return at any time, turn the adjusting screw clockwise until the lever clicks upon return every time. See Figure 8.

**Checkout Procedure**

The circuit between the red and blue leads (terminals) will be closed when sufficient liquid flows through the pipe to trip the flow switch.

Before leaving the installation, observe at least three complete operating cycles to be sure that the Flow Switch and the system to which it is connected are functioning correctly.

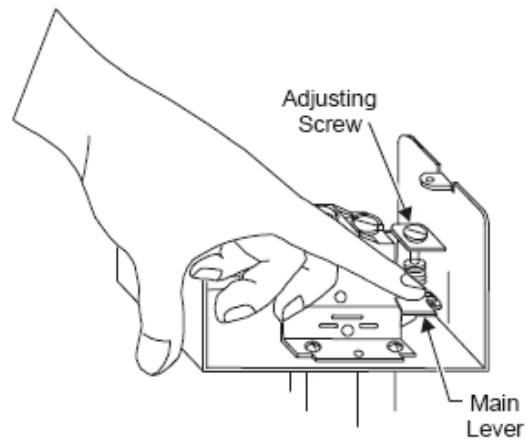

Figure 8 Minimum Adjustment

Table 1 Typical Flow Rate- m<sup>3</sup>/h Required to Actuate Switch

Pipe Size(in.)		1	1-1/4 <sup>a</sup>	1-1/2 <sup>a</sup>	2	2-1/2 <sup>b</sup>	3	4 <sup>c</sup>	5 <sup>c</sup>	6 <sup>c</sup>	8 <sup>c</sup>
Min Adj.	Flow Increase R to B Closes	0.95	1.32	1.70	3.11	4.09	6.24	14.8 (8.4)	28.4 (12.9)	43.2 (16.8)	85.2 (46.6)
	Flow Decrease R to Y Closes	0.57	0.84	1.14	2.16	2.84	4.32	11.4 (6.1)	22.9 (9.3)	35.9 (12.3)	72.7 (38.6)
Max Adj.	Flow Increase R to B Closes	2.0	3.02	4.36	6.59	7.84	12.0	29.1 (18.4)	55.6 (26.8)	85.2 (32.7)	173 (94.3)
	Flow Decrease R to Y Closes	1.93	2.84	4.09	6.13	7.3	11.4	27.7 (17.3)	53.4 (25.2)	81.8 (30.7)	166 (90.8)

- a. Values for 2 in. paddle trimmed to fit pipe.
- b. Values for 3 in. paddle trimmed to fit pipe.
- c. Flow rates for these sizes are calculated installed 1 in., 2 in., 3 in. paddle. Bracket valves are for a switch with a 6 in. paddle, for 4 in. and 5 in. line pipe, the 6 in. paddle is trimmed to a 4 in. and 5 in. length. For 8 in. line pipe, values are for install 1 in., 2 in., 3 in. and 6 in. paddle.

**Table 2 Troubleshooting**

Symptom/Problem	Solution
Liquid from the tank is leaking into enclosure due to bellows failure.	Replace unit.
Switch will not activate due to debris caught within the switch mechanism	Clear any debris within the switch mechanism. Test the operation of switch several times for proper operation
Control switch action is reversed	Ensure connections follow wiring diagrams
Control does not switch	Check connections
Control will switch on flow but won't return when there is no flow	On vertical pipe, ensure that direction of flow is up. The arrow on switch must point in direction of flow (up).
Control does not switch on flow increase	Check for cracked/broken paddle. Replace if necessary

## Technical Specification

<b>Product</b>	<b>FS80-C</b>	
<b>Maximum Fluid Pressure</b>	1.5MPa	
<b>Fluid Temperature</b>	Minimum: -25°C Maximum: 110°C	
<b>Ambient Temperature</b>	Minimum: -20°C Maximum: 60°C	
<b>Electrical Rating</b>	110VAC	220 VAC
<b>Horsepower (HP)</b>	1	1
<b>Full Load Amperes(A)</b>	16	8
<b>Locked Rotor Amperes(A)</b>	96	48
<b>Non-inductive Amperes(A)</b>	16	16
<b>Pilot Duty</b>	125VA at 24~277VAC	
<b>Wiring Connection</b>	Screw Type Terminals	
<b>Paddles</b>	1 in., 2 in., 3 in., 6 in. Paddle are supplied with FS80-C	
<b>Material</b>	SS301	
<b>Switch</b>	SPDT	
<b>Pipe Connection</b>	1" 11-1/2NPT Threads	
<b>Agency listings</b>	CE	
<b>Shipping Weight, lb (kg)</b>	1.26lb (0.57kg)	